

BSF Guidance Manual #2

Maintaining or Cleaning the

Concrete BioSand Water Filter

January 2009

Dr. David H. Manz, P. Eng., P. Ag.

Copyright claimed by David H. Manz January 2009

With use the flow through the filter may become quite slow and cleaning will be required.

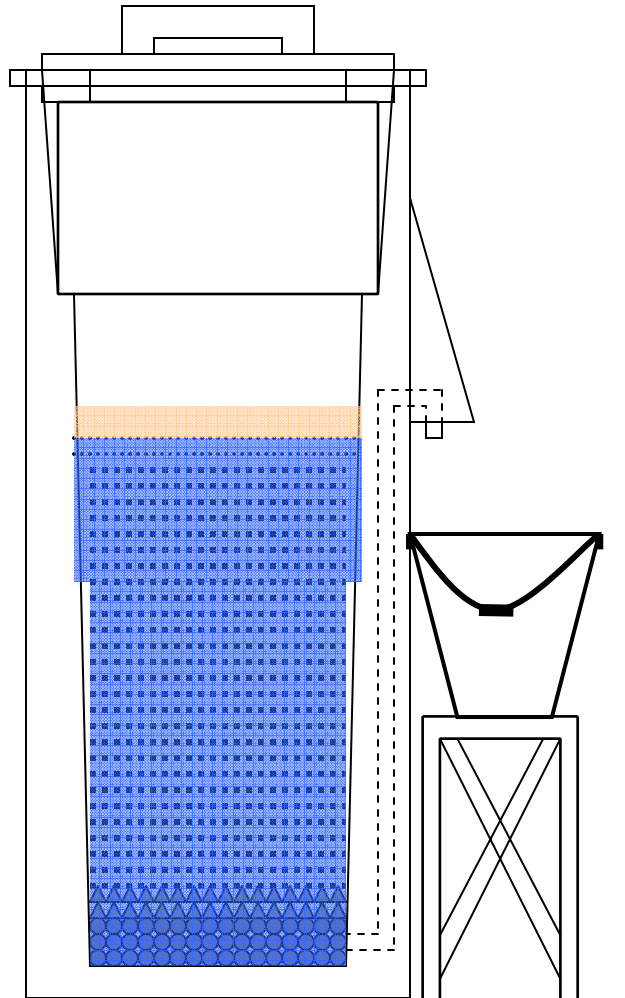

Typical Performance of a BSF Water Filtration Technology

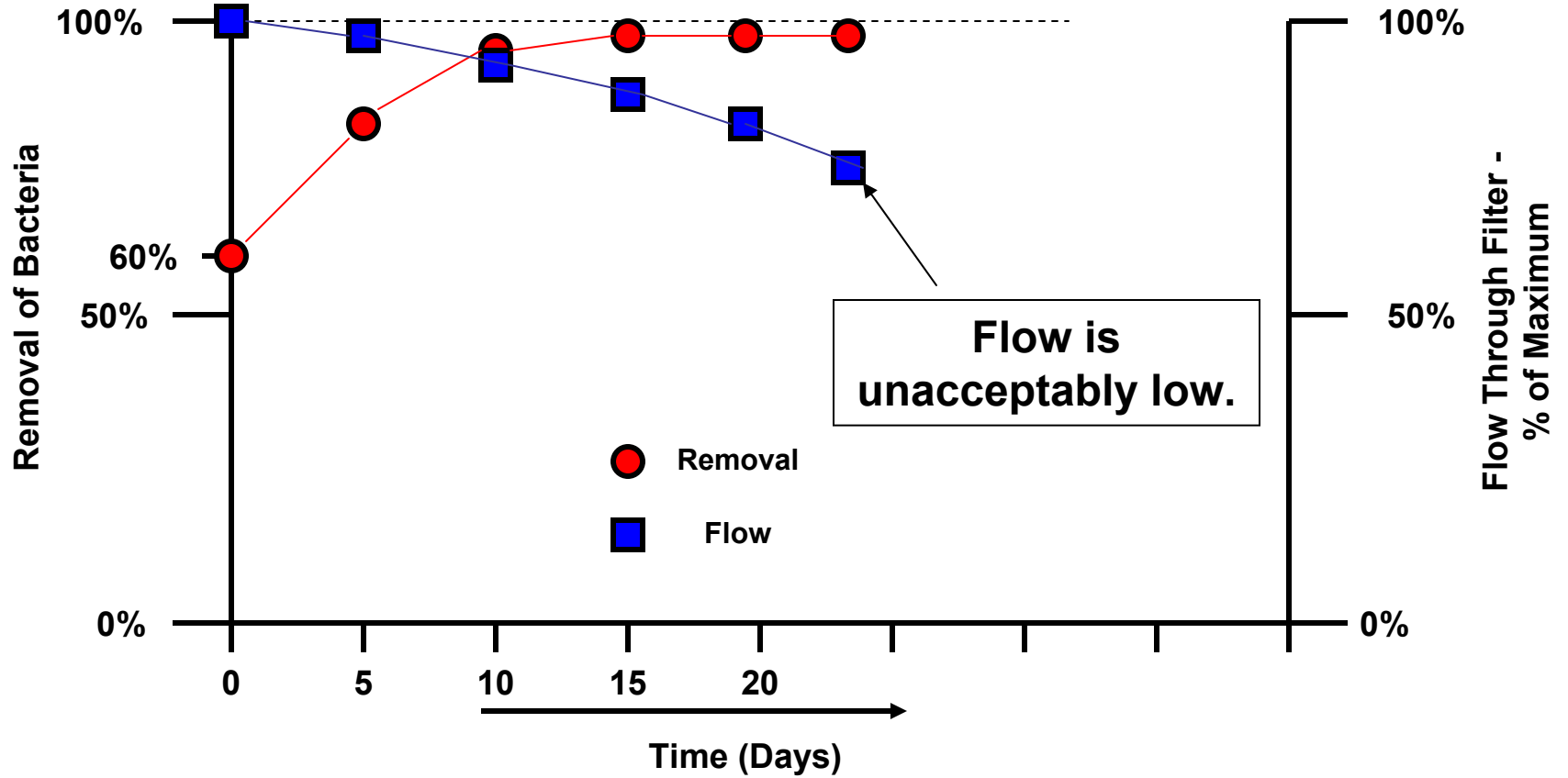

Untreated water is added so that there is approximately 15 cm of water above the surface of the media.

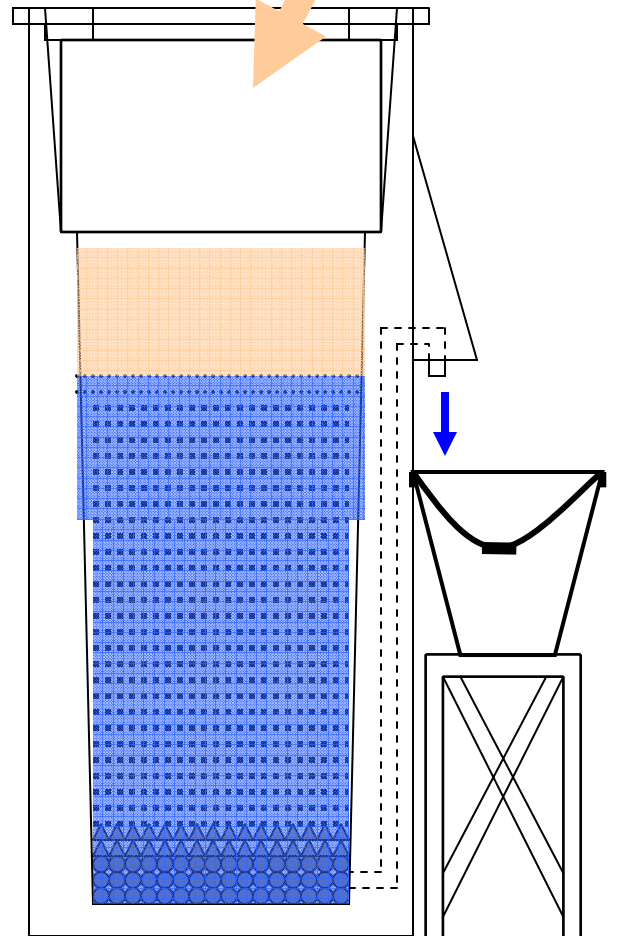
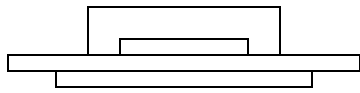

Normal Cleaning Procedure

Remove the lid and diffuser.

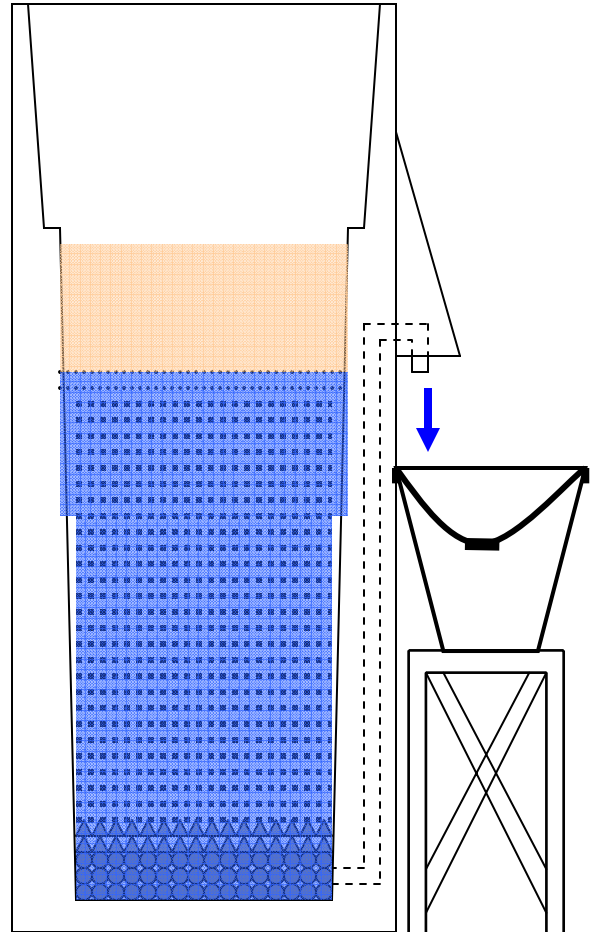
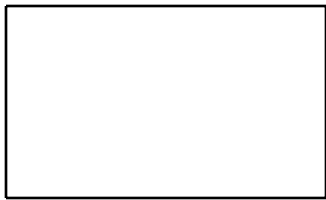
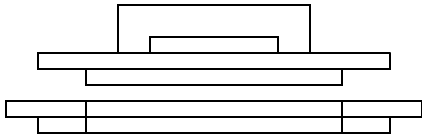

Vigorously agitate the surface without penetrating the filter media more than 1/2 cm or so. The sand will become suspended in the water without actually digging the fingers into it. At the beginning of the process the surface will 'feel' hard. After agitating it will feel soft. The agitation can be performed using the wire fingers, human hand (protected or unprotected) or a stiff brush. Some water contains skin penetrating parasites and immersing the unprotected hand may not be advisable.

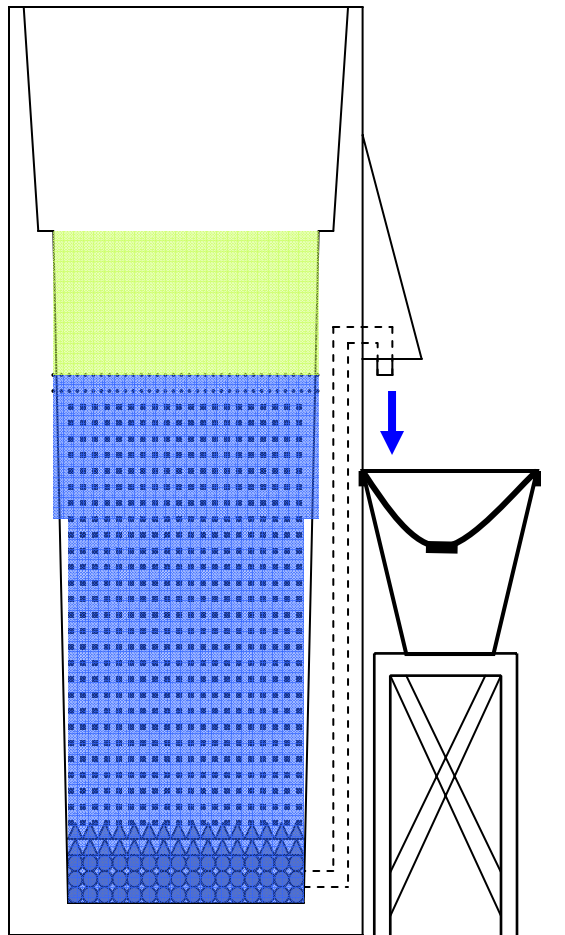

Caution

Do not attempt to clean more than 1/2 to 1 cm below the surface of the media.

Attempting to clean at greater depth will cause the organic material collected at the surface of the filter and media particles forming the biolayer to be 'buried' below the oxygenated zone where the biolayer has formed.

The results of deep cleaning are:

- 1. Destruction of the biolayer.**
- 2. Risk of anaerobic decomposition of buried organic material with resulting discoloration, odor and foul taste of filtered water.**
- 3. Permanent impairment of filter capacity to form a biolayer.**

THE PRACTICE OF 'HARROWING' as advocated by CAWST WILL DESTROY THE EFFECTIVENESS OF THE BSF. (See discussion of the practice and effects of harrowing at the end of this module.)

Normal Cleaning the BSF.

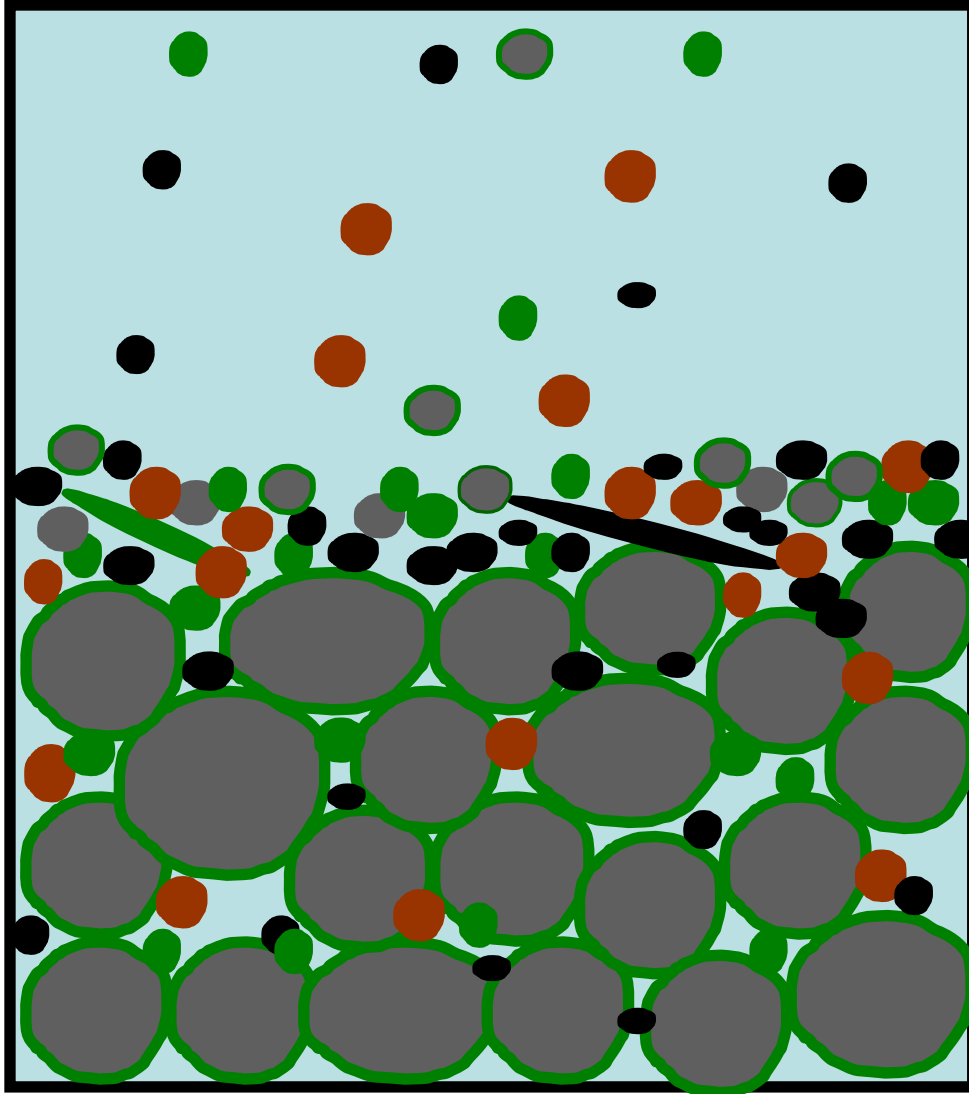

If the water in the filter has been lowered to the paused depth (5 cm) additional untreated water should be added from the top through the diffuser.

Normal Cleaning the BSF.

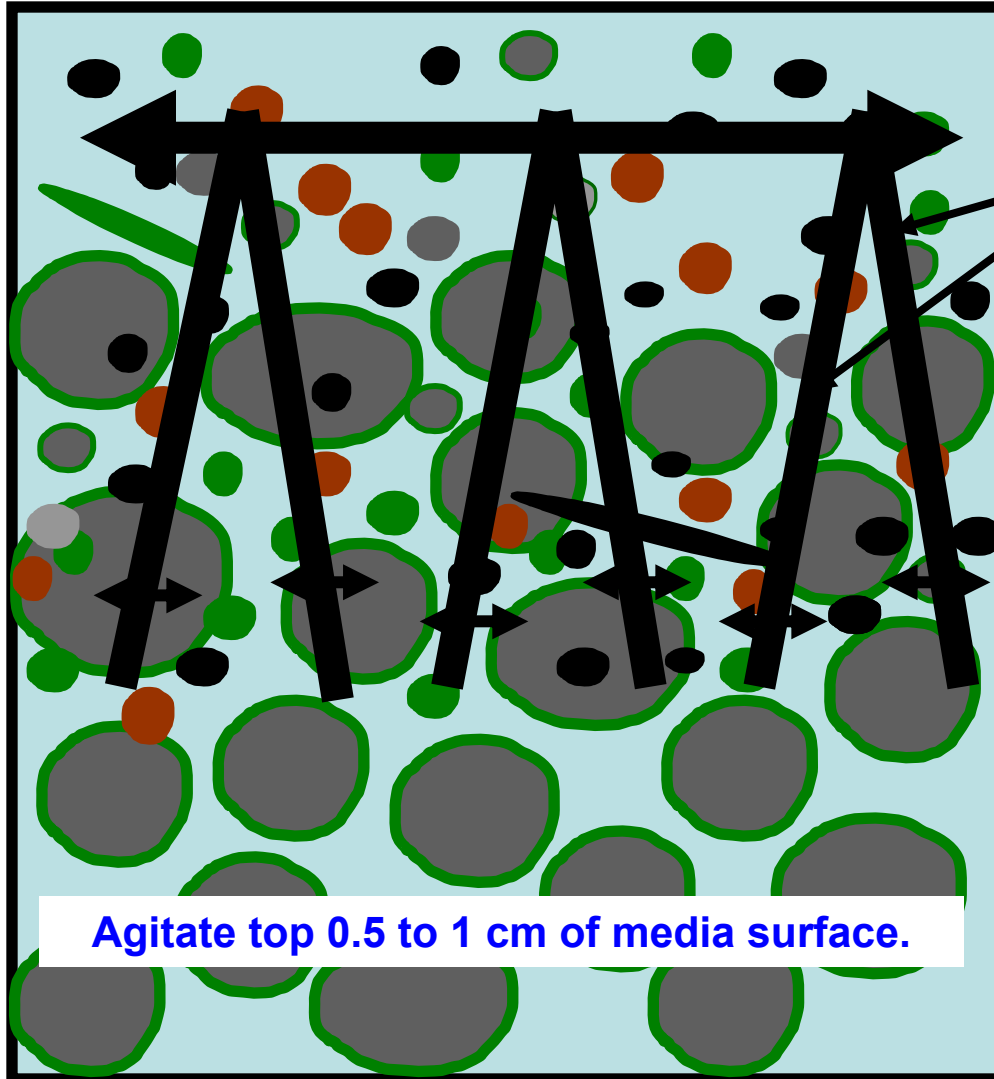

Wire 'fingers', real fingers or a spoon can be used to agitate very top of filtering media where the particles restricting flow are located.

Surface agitation should NOT be confused with 'harrowing' used to extend period between cleanings of TSSF. Harrowing a BSF will seriously impair performance. See further discussion in 'Maintenance and Cleaning of the BSF'. 8

Normal Cleaning the BSF.

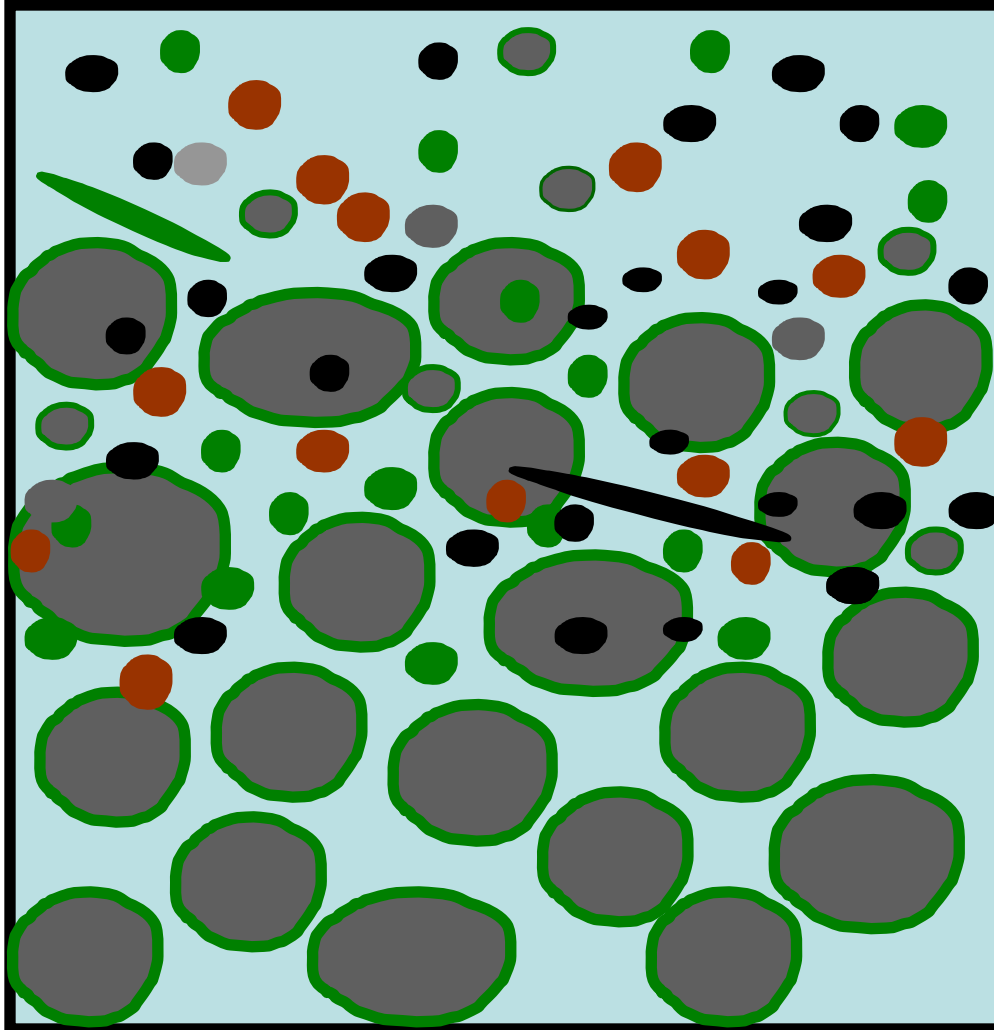

Agitation will continue until most of the particles are suspended in water above the media. This will take $\frac{1}{2}$ minute or so.

Normal Cleaning the BSF.

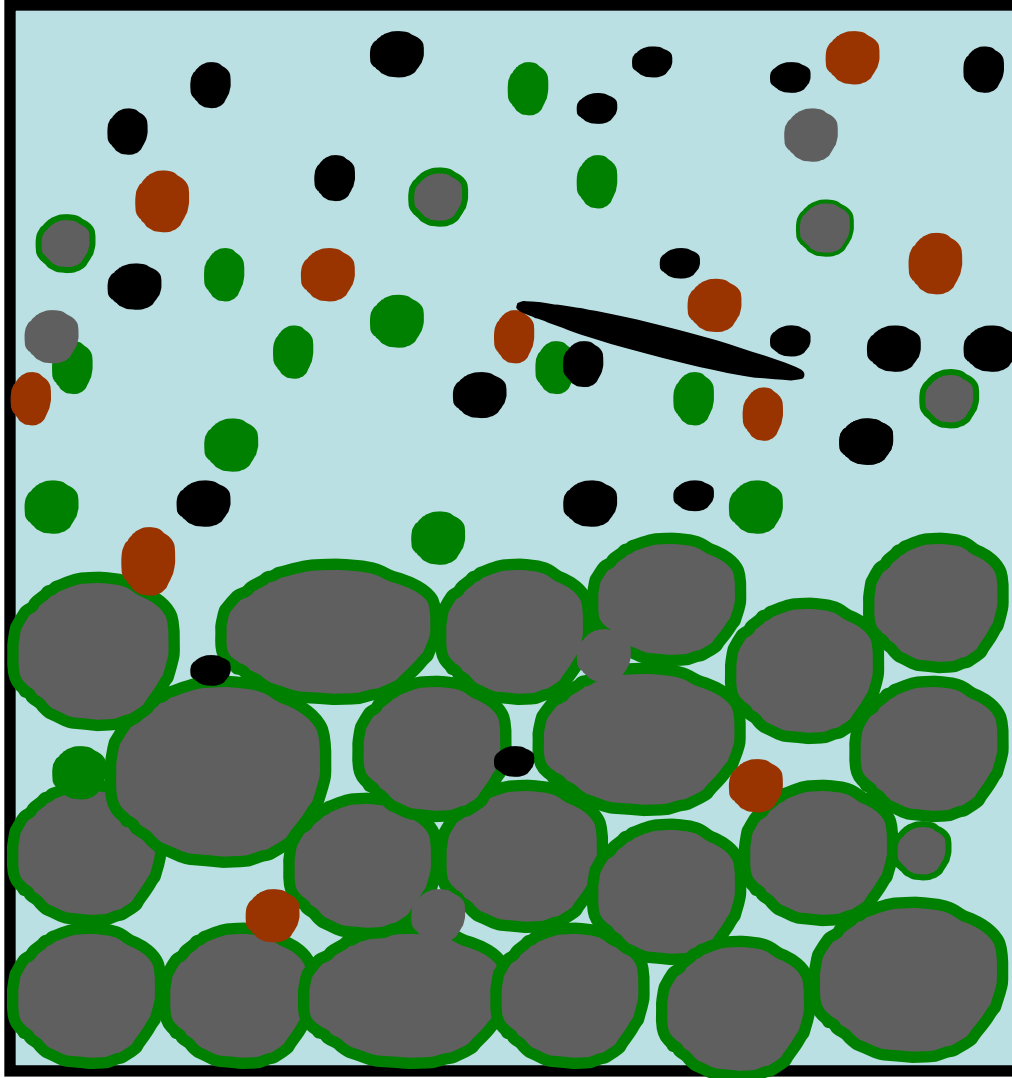

When the agitation is stopped, the media particles coated with a biofilm will settle back into place. The previously captured particles will remain suspended in water above top of media.

Normal Cleaning the BSF.

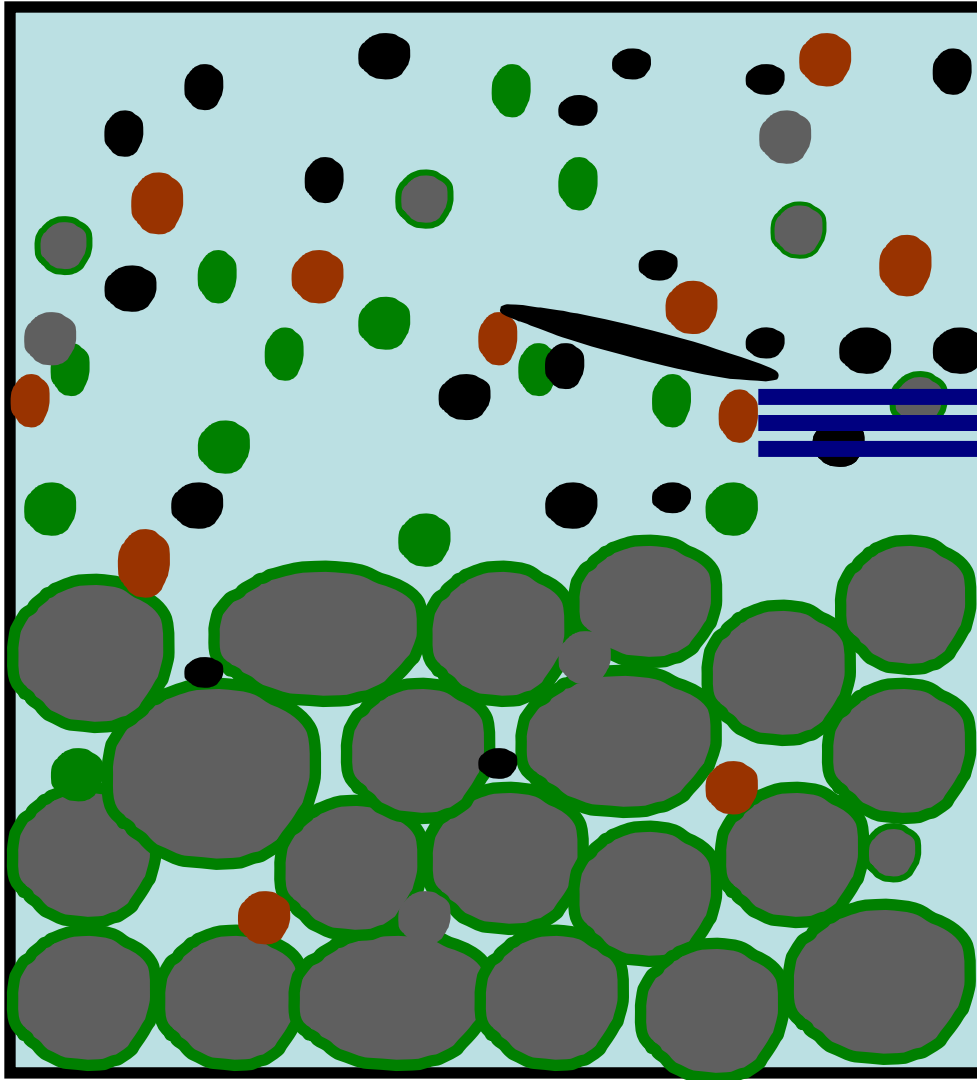

Decant water
containing
suspended particles.

When the agitation is stopped the sand will quickly settle and the contaminants will remain suspended.

Water containing the suspended particles is then removed from the filter using a ladle or cup and the surface of the media is carefully leveled.

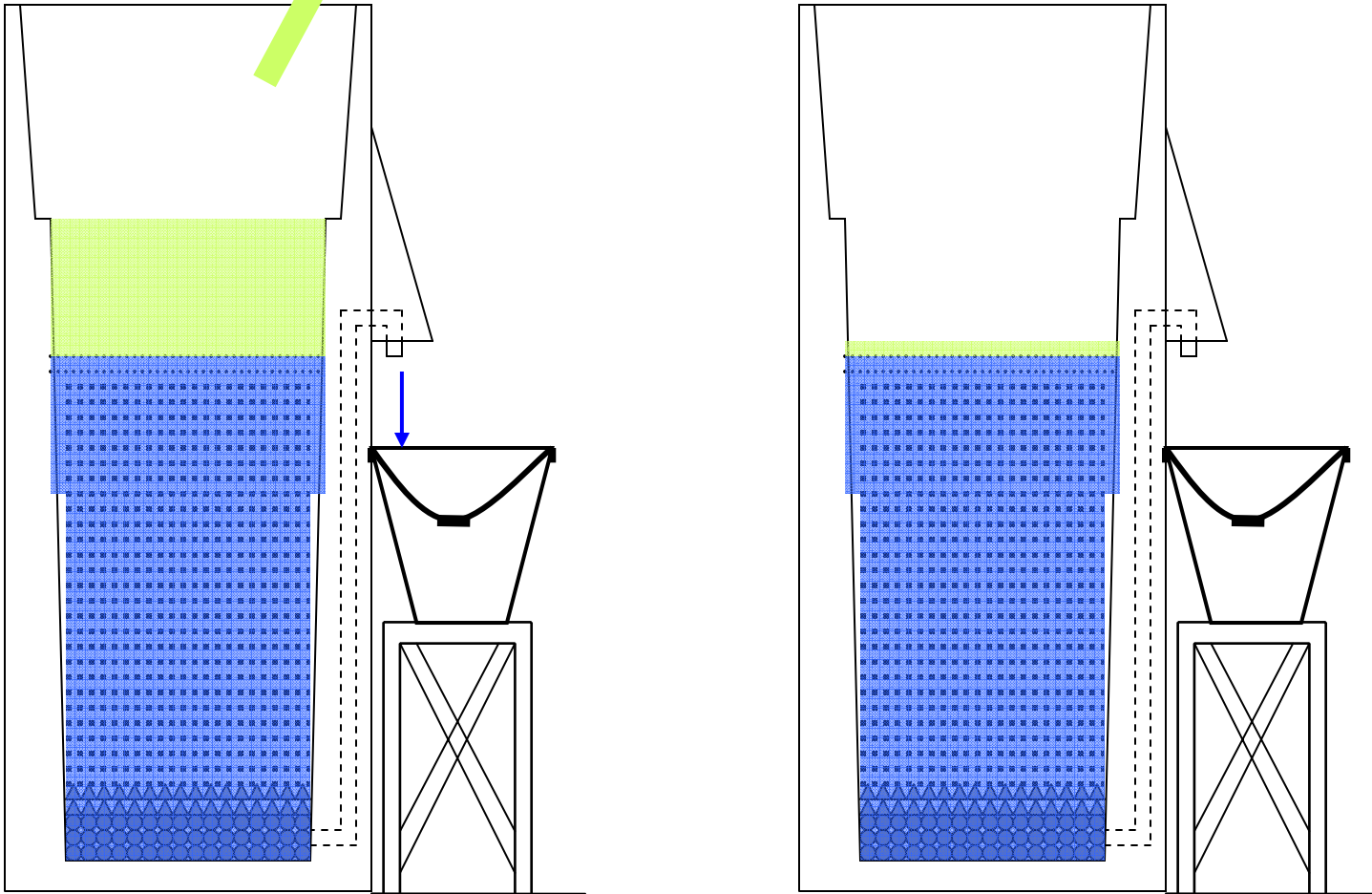

The diffuser and lid assembly are replaced.

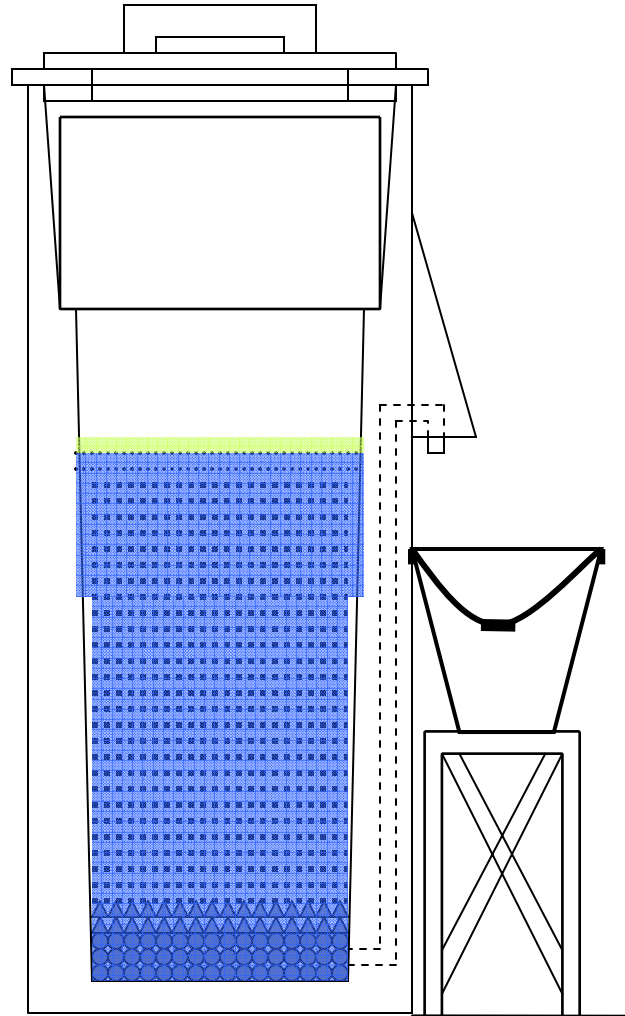

Filter is Ready for Use.

Untreated water added through lid.

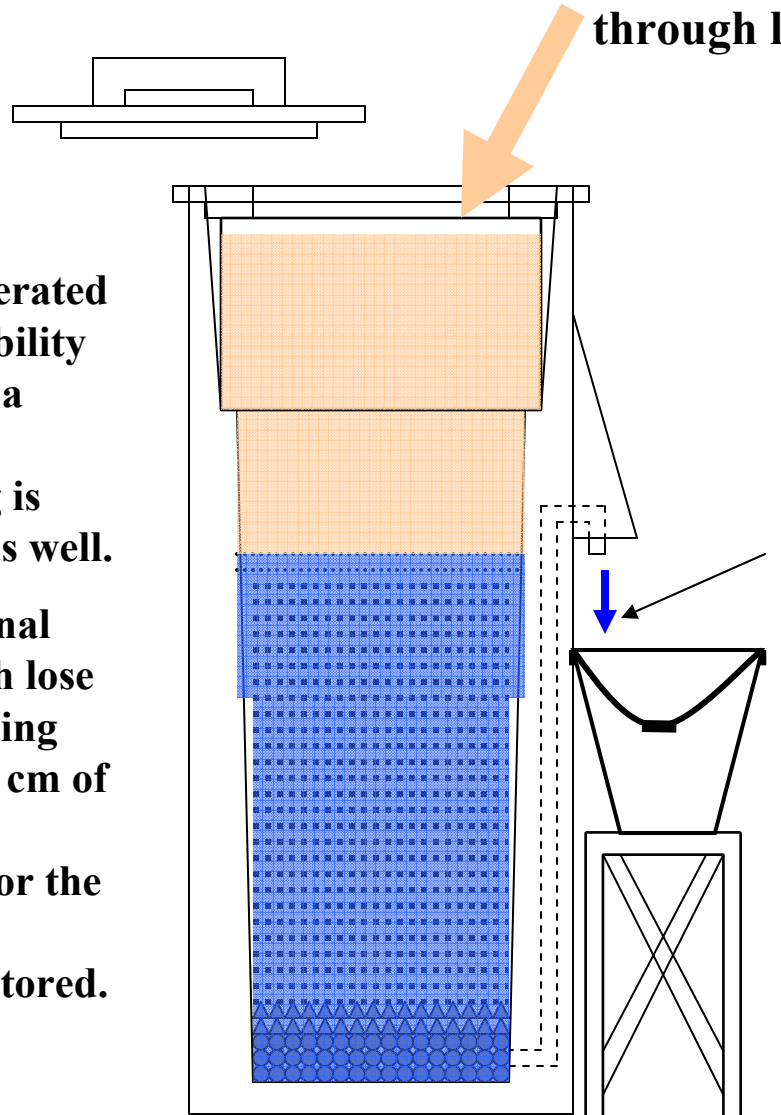

A correctly installed, commissioned and operated BSF will not lose its ability to remove bacteria as a result of cleaning – assuming the cleaning is performed correctly as well.

This is unlike traditional slow sand filters which lose their biolayer after being scraped (removal of 5 cm of surface of media) and require several days for the biolayer and filter performance to be restored.

Flow rate will be restored after cleaning.

Typical Performance of a BSF Water Filtration Technology

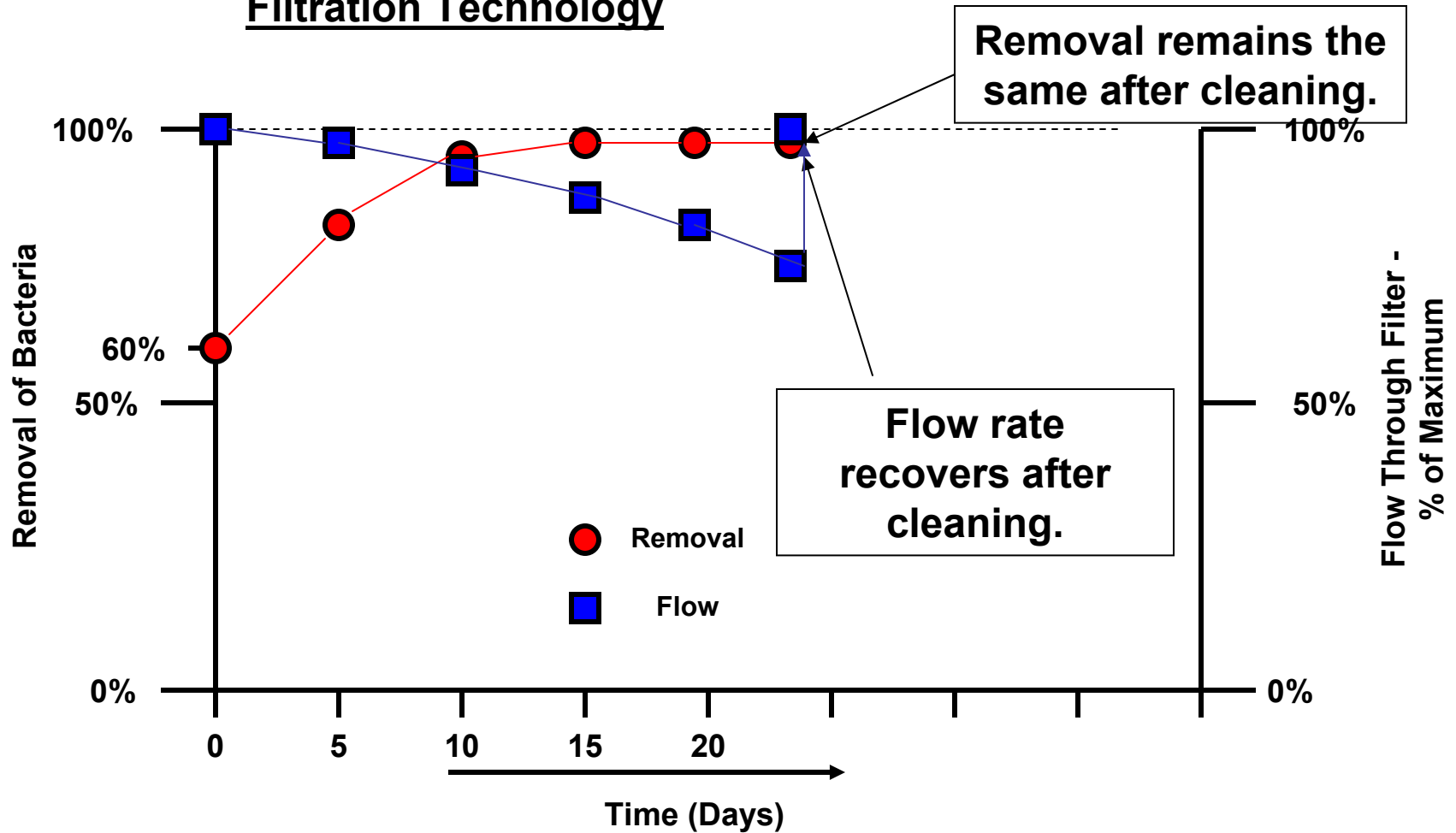

Typical Performance of a BSF Water Filtration Technology

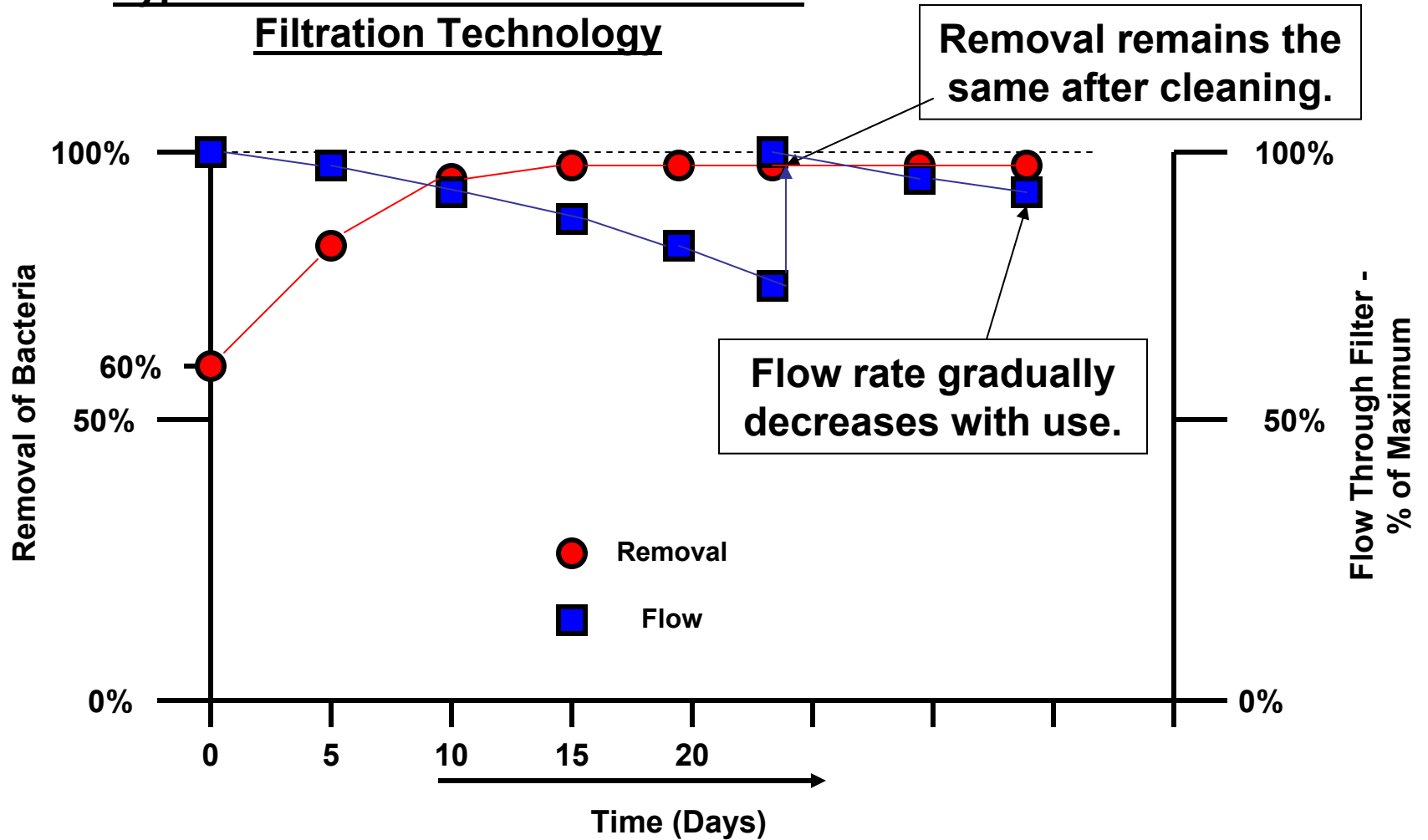

Scraping the BSF

The flow rate through a BSF will gradually decrease over a period of several months or years, depending on the concentration of sediment in the water, even after using correct cleaning procedures.

The reason is that some fine sediments do penetrate deeper into the media and are not removed using the normal cleaning procedure.

It is necessary to remove the top 5 cm or so of the filter media, wash it in filtered water and replace it. (This procedure is similar to that occasionally used when cleaning traditional slow sand filters. No media is discarded or replaced.)

The biolayer will need to reform – a process that will take several days similar to performance recovery experienced after scraping a ‘traditional slow sand filter’.

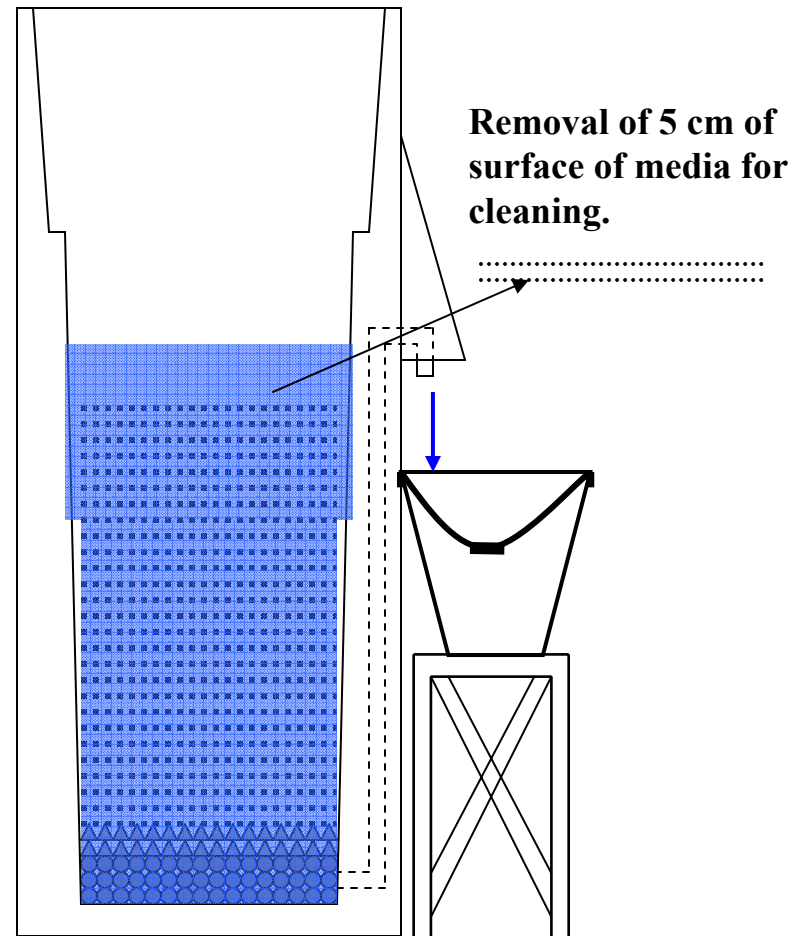

Advantages of recommended method for cleaning the BSF.

Because there is:

- 1. No loss of filter performance with cleaning.**
- 2. No loss of media with cleaning.**

It is practical to use the BSF technology to treat water containing:

- 1. Very high concentration of sediments – cleaned as required.**
- 2. Colloidal particles with use of pretreatment using coagulants.**
- 3. Iron with or without pretreatment depending on water quality.**
- 4. Manganese with pretreatment.**
- 5. Arsenic with or without pretreatment depending on water quality.**

‘Discussion on the Practice of Harrowing as It Applies to the BSF Technology’

The method of cleaning the BioSand Water Filter using vigorous agitation of the surface of the media should NOT be confused with the process used to extend the period between the cleaning of traditional slow sand filters known as ‘harrowing’.

Traditional slow sand filters MUST be operated continuously or they will FAIL. When operated continuously traditional slow sand filters will develop a deep (several centimeter deep) oxygenated zone and biolayer. The BSF can only develop a shallow biolayer because the oxygenated zone is less than 1 cm deep. Harrowing the surface of a traditional slow sand filter will remove surface material blocking flow (algae and other aquatic plants), stir the biolayer and temporarily ‘open it up’ resulting in increased flow. To be successful harrowing cannot be deeper than the oxygenated zone.

**Particles with
Biolayer BEFORE
Harrowing the
surface of the
media in a BSF.**

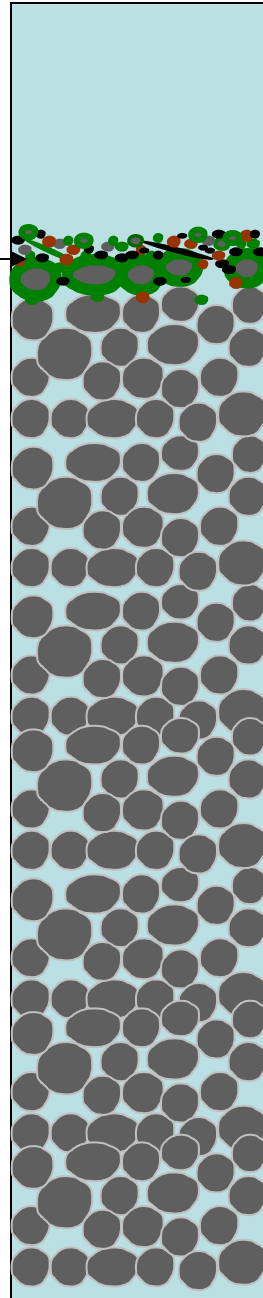

↓
Biolayer
↑

**Particles with
Biolayer AFTER
Harrowing.**

Note that particles associated with biolayer and particles plugging surface pores are scattered well into the surface of the media (5 cm or more). These particles will not receive oxygen when the filter operation is paused. The result is poor filter performance, smell and discoloration of water.

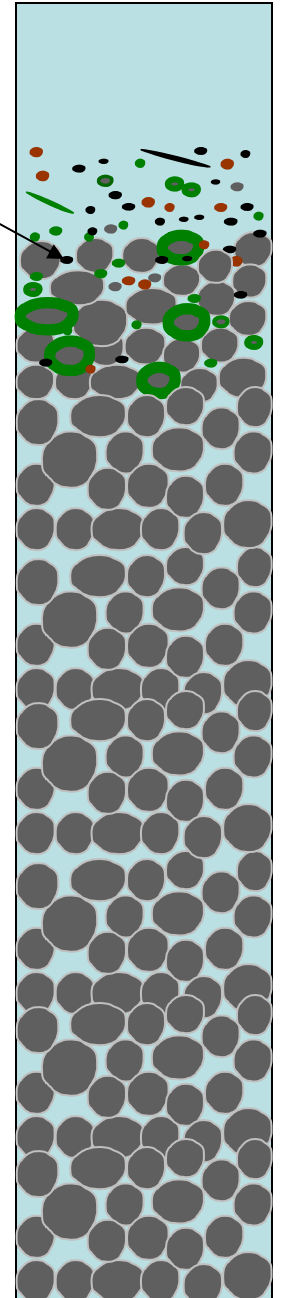

Performance of a BSF Water Filtration Technology if HARROWED.

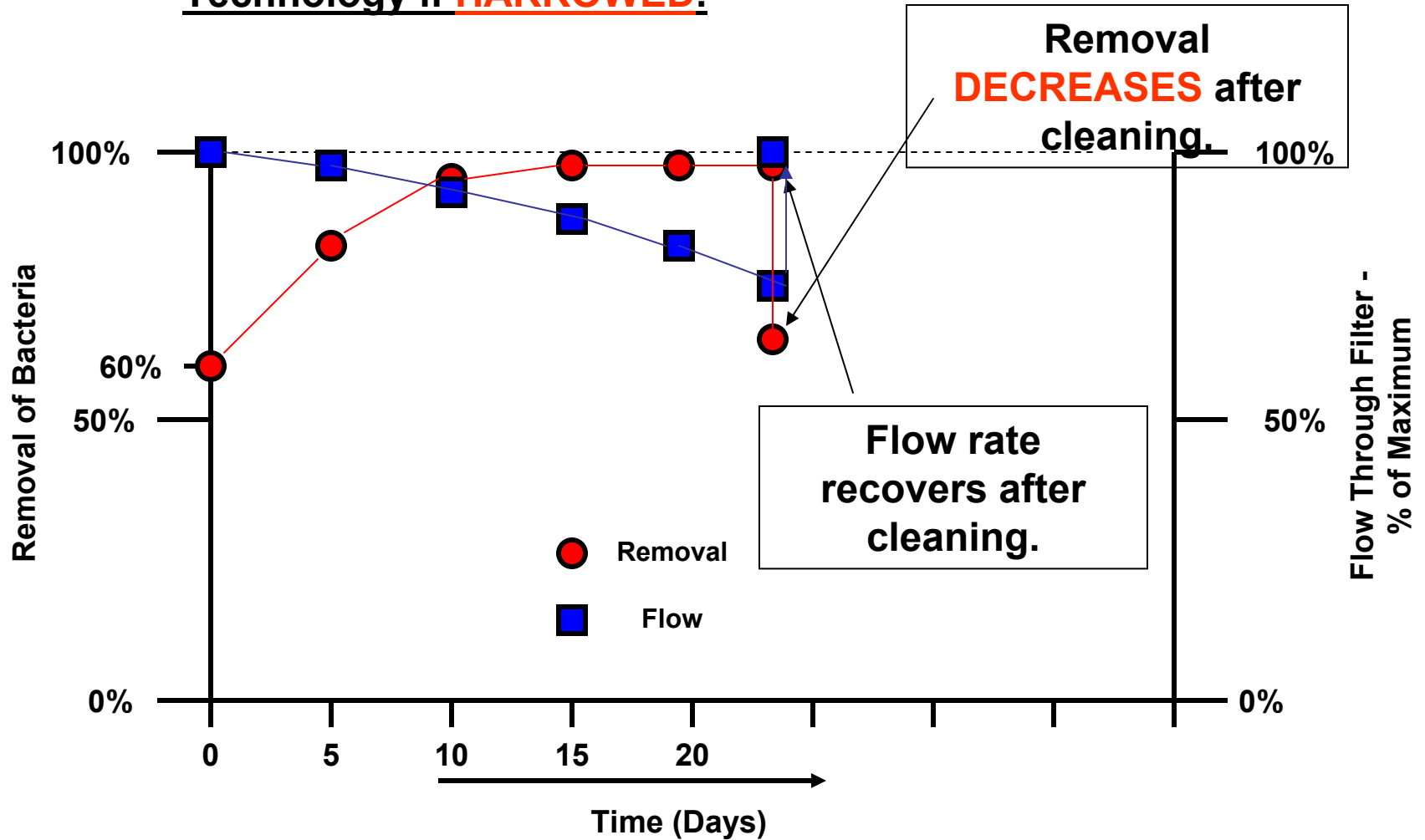

Performance of a BSF Water Filtration Technology if HARROWED.

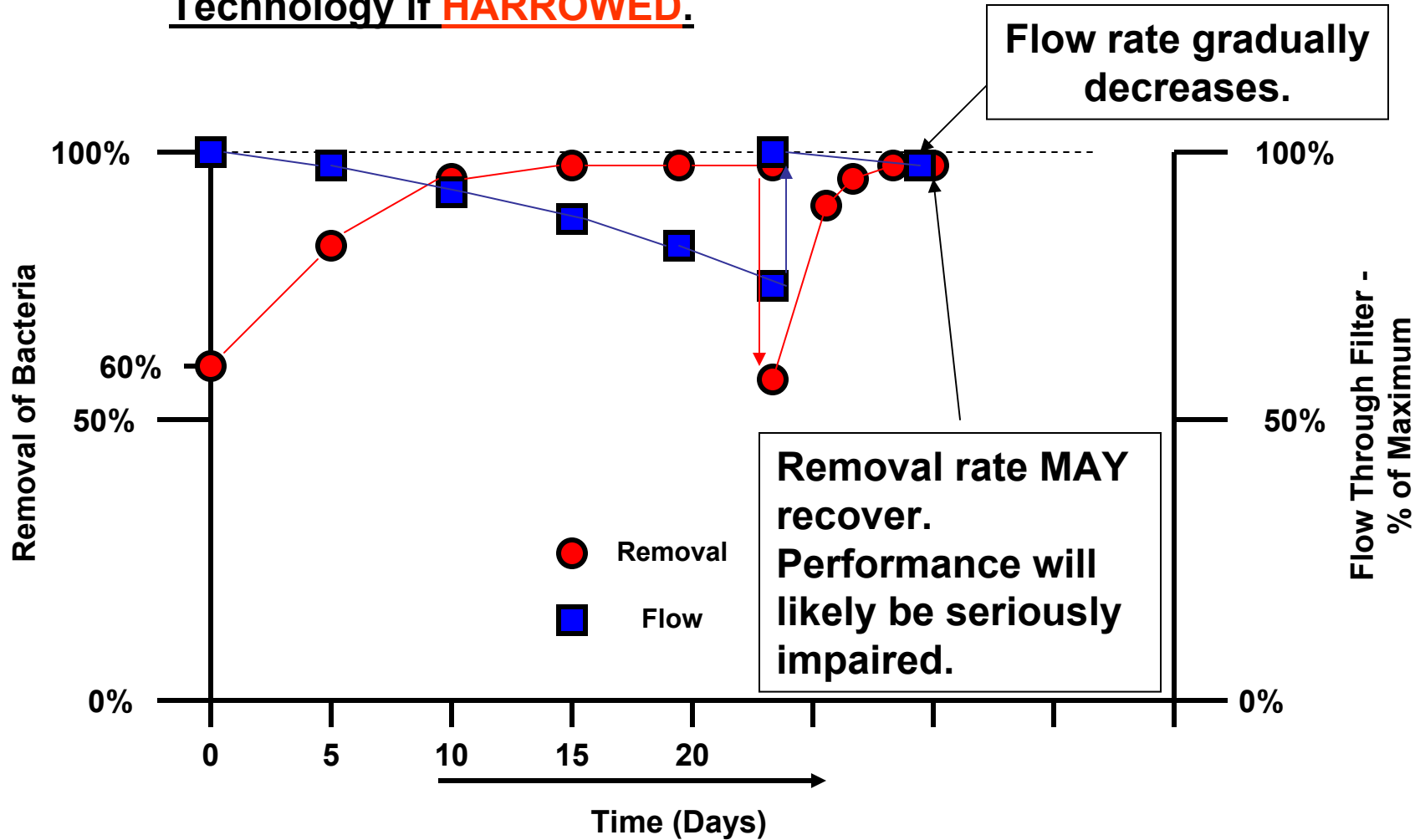

Harrowing a BSF may result in performance much worse than traditional slow sand filtration.

'Harrowing'

Harrowing of the BioSand Water Filter will:

- 1. Impair the ability of the BSF to remove bacteria and viruses.**
- 2. Likely result in decrease in flow as near surface gradually plugs up with trapped particles.**
- 3. Likely result in anaerobic decomposition of organic material forming biolayer surrounding particles and organic particles themselves.**
- 4. Likely observe the development of foul odor as a result of anaerobic decomposition.**
- 5. Likely observe the development of color in filtered water as a result of anaerobic decomposition.**
- 6. May result in the development of 'off-taste' of filtered water as a result of anaerobic decomposition.**

Clearly, harrowing may result in FAILURE OF THE BSF TECHNOLOGY!

Organizations such as the Centre for Affordable Water and Sanitation Technology (CAWST) advocate 'harrowing'; and, they correctly observe that the biolayer will need to recover after each 'cleaning' using this technique (unfortunately). What is not observed is that the performance of the BSF will deteriorate with every 'harrowing procedure'.

Good luck!